

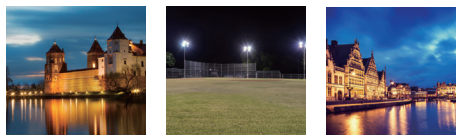

MÄSTARE300

OUTDOOR SERIES

KAP-FLI-300



Electrical / Electrique

Power / Puissance	312 W
Input voltage / Tension d'entrée	100 - 277 V
Input current / Courant d'entrée	4.0 A MAX
Frequency / Fréquences	50 - 60 Hz
Power factor / Facteur de puissance	> 0.9
Dimmable type / Type de dimmage	0-10 V / PWM / VR

Lighting / Eclairage

Beam angle / Angle de faisceau	90°X120°
Efficiency / Efficacité	114 Lumens/w
Lumen output / Sortie lumens	35800 Lumens
CRI / IRC	> 80
Color temperature / Température de couleur	3000 - 3500 K 4000 - 4500 K 4800 - 5100 K 5200 - 5700 K

Components & fixture / Composants et structure

Body material / Matériau du corps du projecteur	Aluminum / Aluminium
Product painting color / Couleur de la peinture	Silver grey / Gris argenté Black / Noir
Screws material / Matériau des visseries	Stainless steel 316 / Acier inoxydable 316
Cover material / Matériau du couvercle	PC lens / Lentilles en Polycarbonate
Cable specifications / Spécifications du cable	HO5RNF (3G1.0mm ²)
LED Chipset / Puces LED	Lumileds Luxeon 3030
Cable length / Longueur du cable	0.5m / 1.0m

Temperatures / Températures

Storage temperature / Température de stockage	-40°C ~ +80°C
Operating temperature / Température d'utilisation	-20°C ~ +40°C
Storage Humidity / Humidité de stockage	10% - 90%

Additional product data / Informations supplémentaires

Lifetime / Durée de vie	> 50.000 Hours
Warranty / Garantie	5 years / 5 ans
International Standards / Normes internationales	Eco-Design(ERP)



Model number / Numéro de référence

Example for MÄSTARE 300 with black painting / color temperature 4000K / 0.5m cable
 Exemple pour MÄSTARE 300 avec peinture noir / couleur de temperature 4000k / cable 0.5m

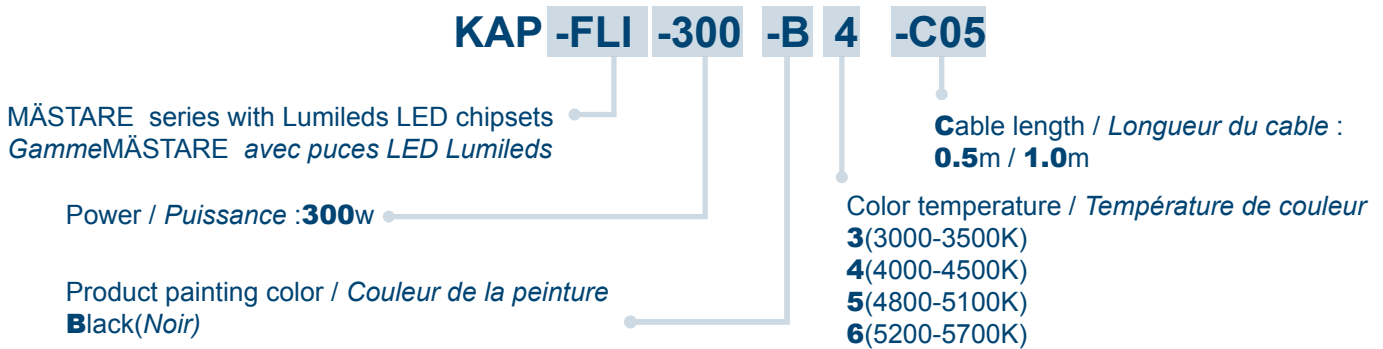

Product Dimensions

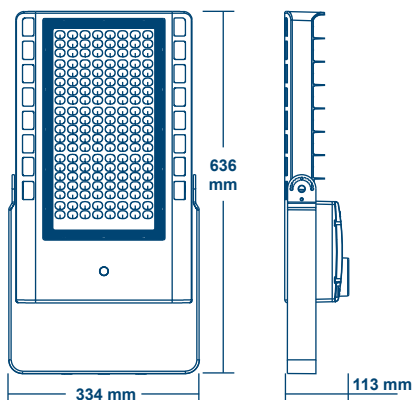

Photometry / Photométrie

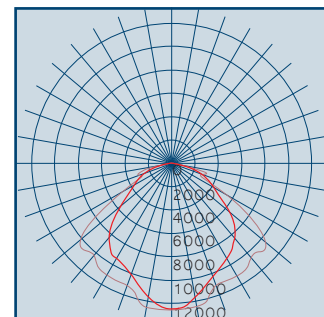

Packing Information / Information Colisage

Packing details	Size (mm)	Qty / ctn(pcs)	Net Weight (kg)	Gross Weight (kg)
Product	636*334*113	/	10.2	/
Inner box	/	/	/	/
Master Carton	670*375*160	1	/	11.0